

114 & 114-R Batten Panel

114 Panel

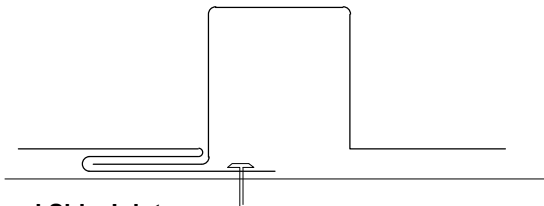
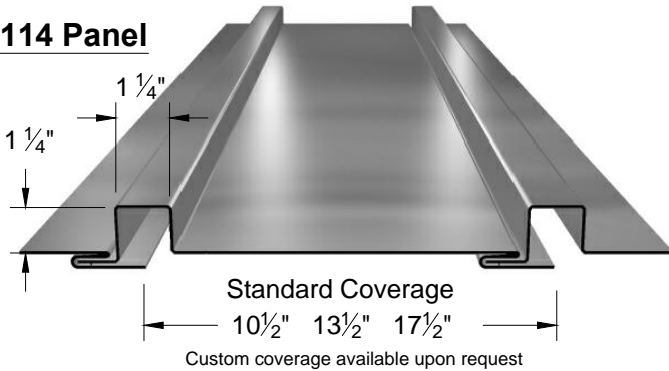

Panel Side Joint

Popular integral batten, narrow seam with snap-fit side joint design permits fast and easy installation. Recommended for shorter panel lengths.

114-R Panel

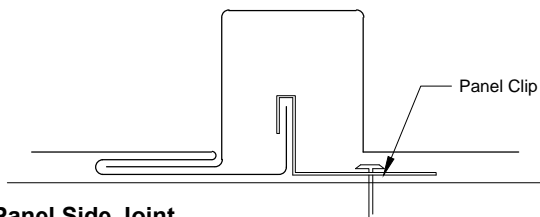
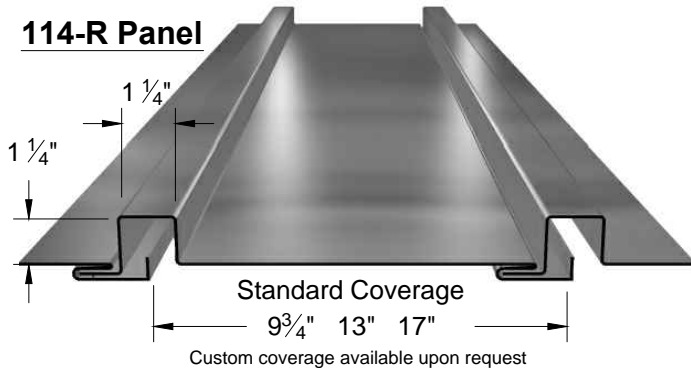

Panel Side Joint

Modified 114 panel with bend for the extruded aluminum clip. Recommended for longer lengths to accommodate thermal expansion and contraction of the panel.

Applications

Architectural roofing on slopes 3" or greater.
Continuous lengths up to 45 ft. Vertical walls, conical tapers.

Substrates

Solid deck / Plywood or Rigid insulation over decking
Requires minimum 30# felt underlayment.
Requires rosin slip sheet for roof application.

Materials

Materials	Standard Gauges
Aluminum (3000 series alloy)	.032" .040"
Galvanized coated steel (G-90)	24 ga. 22 ga.
Alum-Zinc coated steel (AZ-50 & AZ-55)	24 ga. 22 ga.
Copper & lead coated Copper	16 oz. 20 oz.

Also available in Zinc, Pre-Weathered Zinc & Stainless Steel

Finishes

Kynar & Metallic Fluoropolymer Coatings
Mill Finish, Brushed, Anodized
Texture: Smooth or Stucco Embossed

Manufacturing

Factory Formed

Some panels configurations are not suitable for all applications.
Contact sales & engineering for more information.

Components

#114-R Clip

One piece corrosion resistant extruded aluminum clip. Used for aluminum panels longer than 10 feet and steel panels longer than 15 feet. Clip permits free thermal expansion and contraction of panel. For shorter panel lengths, utilize the #114 profile and screws for fastening the panels to the substrate.

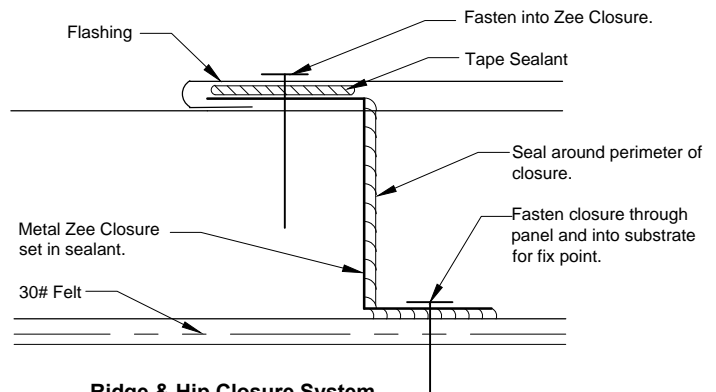
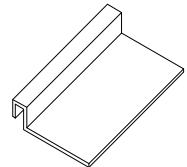

Ridge & Hip Closure System
10' metal Zee closure.

Updated December 2011

Merchant & Evans, Inc.
308 Connecticut Drive
Burlington, NJ 08016

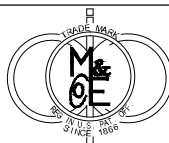

Phone: 800-257-6215
Phone: 609-387-3033
Fax: 609-387-4838
www.ziprib.com